

**Barrier Latch
with Standard
PVC Safety Bolt**

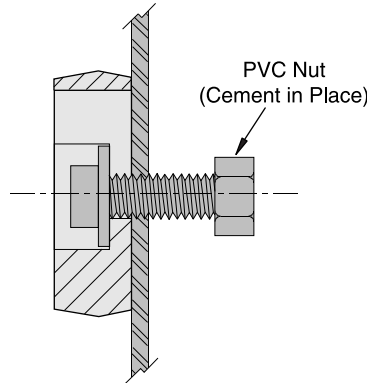

Section AA

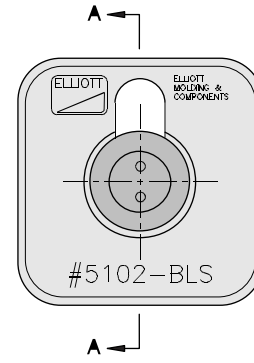

**Barrier Latch
with RUS Accepted
PVC Safety Bolt**

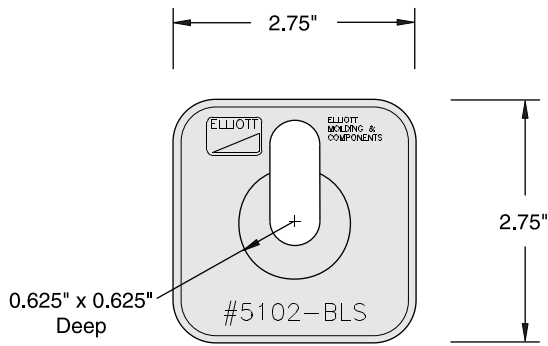

Front View

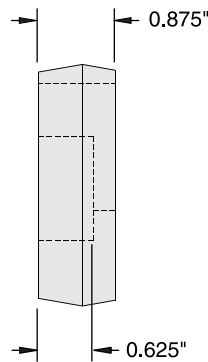

Side View

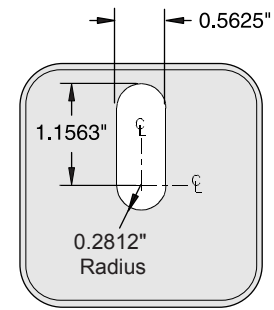

Rear View

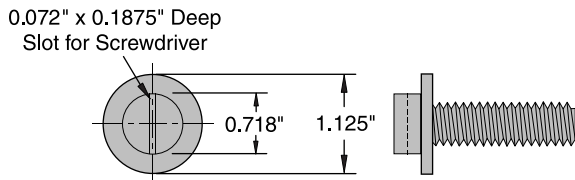

**0.5"-13 x 1.75"
Standard PVC Safety Bolt**

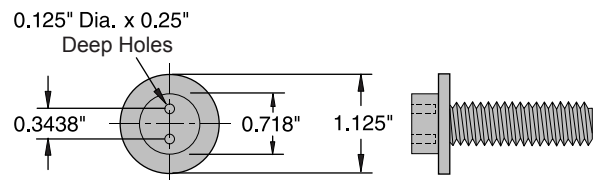

**0.5"-13 x 1.75"
RUS Accepted PVC Safety Bolt**



**#5102-BLS Cycloaliphatic Epoxy
Door Barrier Safety Latch**

Descriptive
Bulletin
5102
Page 2 2015

**If you do not find the design
you need**

PLEASE CONTACT

our REPRESENTATIVE or the FACTORY